

DESCRIPTION

The MMS742xxx-24-x1 is part of a family of fully integrated smart motor solutions for servo motor applications. This 42mm (NEMA 17) motor integrates a brushless DC (BLDC) motor and driver module inside.

The MMS742xxx-24-x1 supports three control modes: profile position (PP), profile velocity (PV), and profile torque (PT). It also has four isolated I/Os for external signal input and output.

MotionLAB is an easy-to-use GUI software that allows users to flexibly optimize the design online via the RS-485 control interface. The parameters are saved in the motor's non-volatile memory (NVM). The GUI and its user guide are available for download at www.EZmotion.co.

In addition to fully integrated smart motor solutions, the driver modules and accessories can be ordered separately for customization into different motor types.

FEATURES

- SRS Series for RS-485 and Step/Direction Control Interface
- SSD Series for Step/Direction Control Interface
- 18V to 36V Input Voltage (V_{IN}) Range
- 38W to 105W Continuous Output Power (P_{OUT})
- 0.12Nm to 0.25Nm Nominal Torque
- 0.36Nm to 0.75Nm Peak Torque
- 0.3° Position Resolution
- Three Different Control Modes: Profile Position (PP), Profile Velocity (PV), and Profile Torque (PT)
- Driver Module Temperature Sensing
- Operating Temperature: 0°C to 70°C (Power Derated > 40°C)
- Storage Temperature: -40°C to +125°C

PRODUCT INFORMATION

Part Number	Diameter (mm)	Power (W)	Nominal Voltage (V)	Control Mode	Control Interface
MMS742038-24-R1-1	42	38	24	PP, PV, PT	RS-485, step/direction
MMS742038-24-S1-1	42	38	24	PP, PV, PT	Step/direction
MMS742052-24-R1-1	42	52	24	PP, PV, PT	RS-485, step/direction
MMS742052-24-S1-1	42	52	24	PP, PV, PT	Step/direction
MMS742077-24-R1-1	42	77	24	PP, PV, PT	RS-485, step/direction
MMS742077-24-S1-1	42	77	24	PP, PV, PT	Step/direction
MMS742105-24-R1-1	42	105	24	PP, PV, PT	RS-485, step/direction
MMS742105-24-S1-1	42	105	24	PP, PV, PT	Step/direction

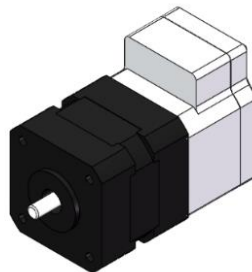

There are two accessory packages available for order that are used for driver module evaluation. The MMA02-3001 includes the EZmotion communication kit and cable. The MMA03-3001 also includes the matching connectors for the MMS742xxx-24-x1.

Part Number	Component	Description	Quantity
MMA02-3001	EZmotion communication kit	USB to RS-485/I ² C/SPI converter	1
	USB cable	1.5m, USB Type-A to USB Type-B cable	1
	Dupont line	Dupont wires, 3-pin	1
MMA03-3001	KF12EKD-2.5-3P-1G	2.5mm pitch, 3-position connector	1
	KF12EKD-2.5-4P-1G	2.5mm pitch, 4-position connector	1
	KF12EKD-2.5-5P-1G	2.5mm pitch, 5-position connector	1

PRODUCT SPECIFICATIONS

Parameter	Condition	Value				Units
		38W	52W	77W	105W	
DC input voltage (V_{IN})		24				V
V_{IN} Range		18 to 36				V
Continuous output power (P_{OUT})	0°C to 40°C	38	52	77	105	W
Logic pin voltage range		0 to 5.5				V
Nominal speed		3000	4000			rpm
Continuous output torque	0°C to 40°C	0.12	0.125	0.185	0.25	Nm
Peak output torque	0°C to 40°C, <10s	0.36	0.375	0.555	0.75	Nm
Rotor inertia		24	48	72	96	gcm ²
Position resolution		0.3				deg
Length		73.5	93.5	113.5	133.5	mm
Weight		300	500	700	850	g
RS-485 baud rate	Configurable	9600bps to 2Mbps, default 115200				bps
Pulse frequency		<500				kHz

RECOMMENDED OPERATING CONDITIONS

Input voltage (V_{IN}) 18V to 36V
 Control interface voltage 0V to 5.5V
 Maximum pulse frequency 500kHz
 RS-485 A/B voltage 0V to 5.5V
 RS-485 common-mode voltage ±15V
 Operating temperature 0°C to 70°C
 Storage temperature -40°C to +125°C

HARDWARE CONNECTIONS

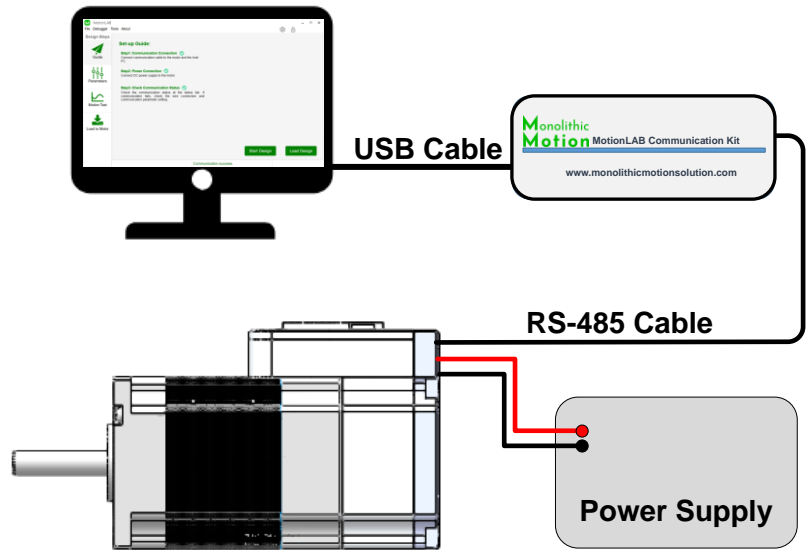

Figure 1: Connect Servo Motor to MotionLAB GUI

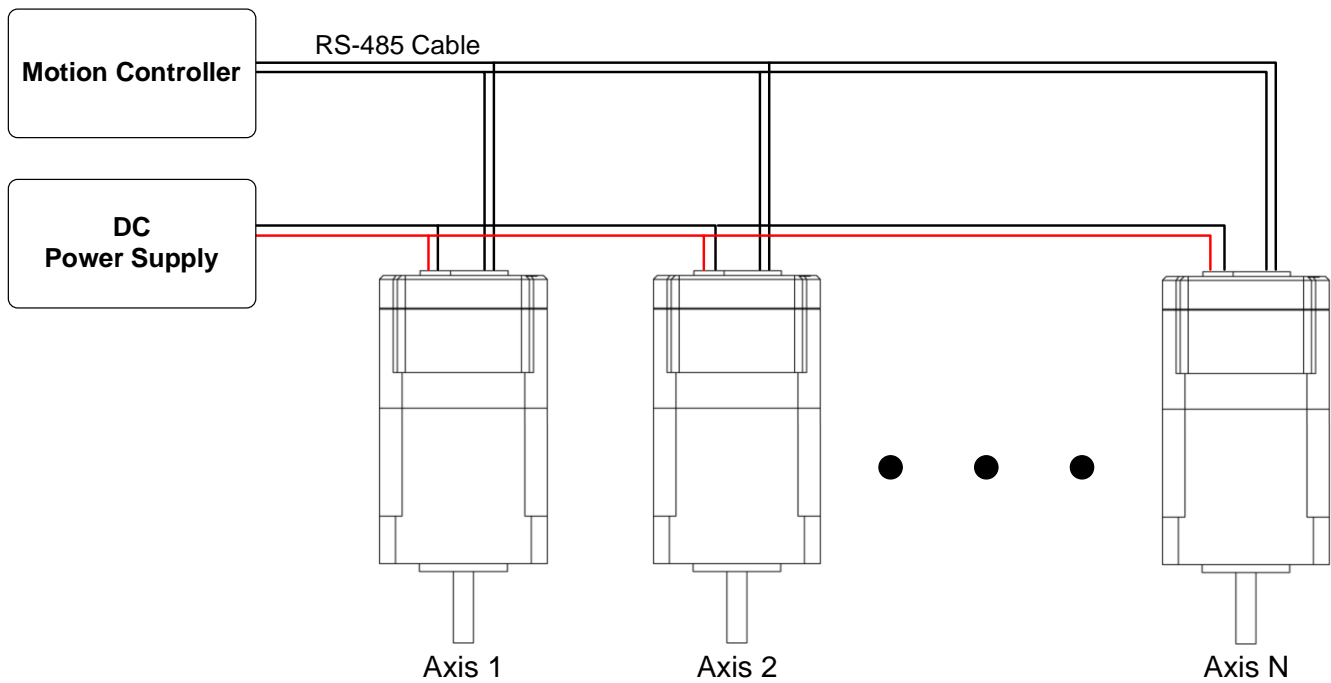
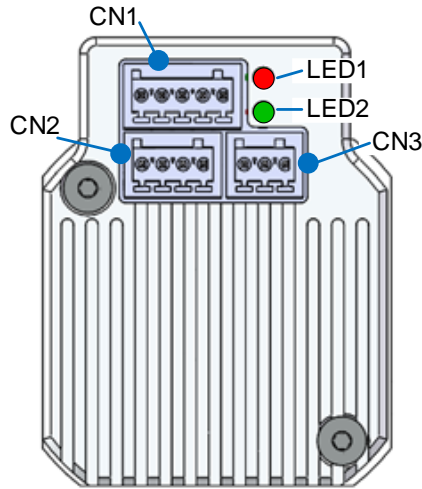

Figure 2: Multi-Axis Application Connection

PIN CONFIGURATION



- CN1: I/O Interface
- CN2: RS-485 Interface
- CN3: Power Interface
- LED1: Fault Indicator
- LED2: Power Indicator

MMS742xxx-24-x1 Pin Definitions ⁽¹⁾

I/O Interface (CN1)

CN1 Pin Number	Designation	Pin Description
1	COM-	Common return
2	DI1+	Digital input 1
3	DO1+	Digital output 1
4	DI2+	Digital input 2
5	DI3+	Digital input 3

RS-485 Interface (CN2)

CN2 Pin Number	Designation	Pin Description
1	EXT 5V	5V input for firmware configuration
2	B	RS-485 node B
3	AGND	RS-485 ground
4	A	RS-485 node A

Power Interface (CN3)

CN3 Pin Number	Designation	Pin Description
1	GND	Power ground
2	R-	Shunt resistor return node
3	VIN	Input power supply

Note:

1) The leftmost pin of each connector is pin 1.

TYPICAL PERFORMANCE CHARACTERISTICS

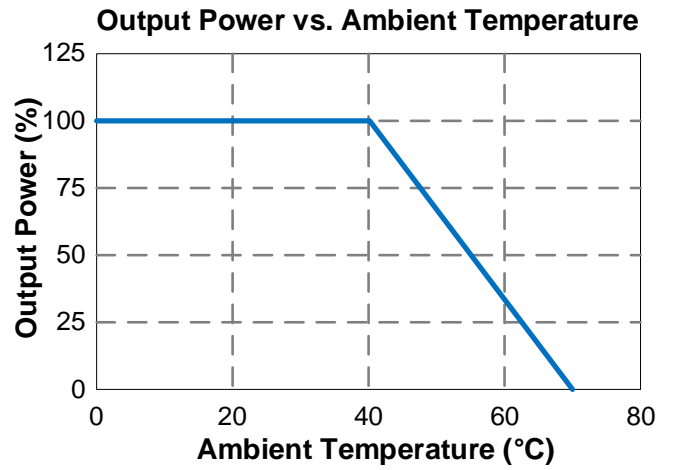
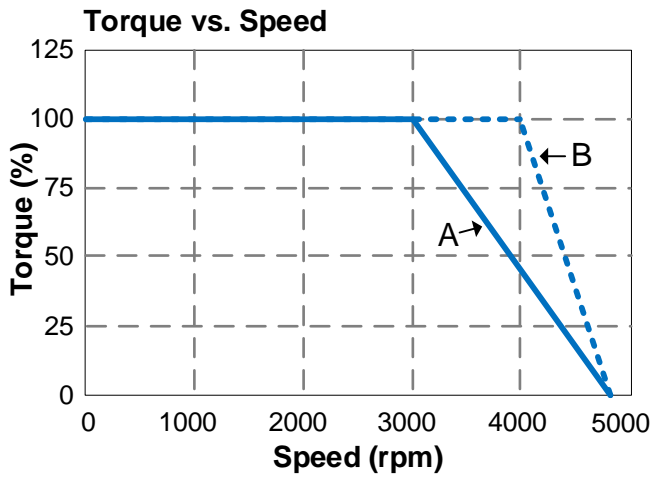
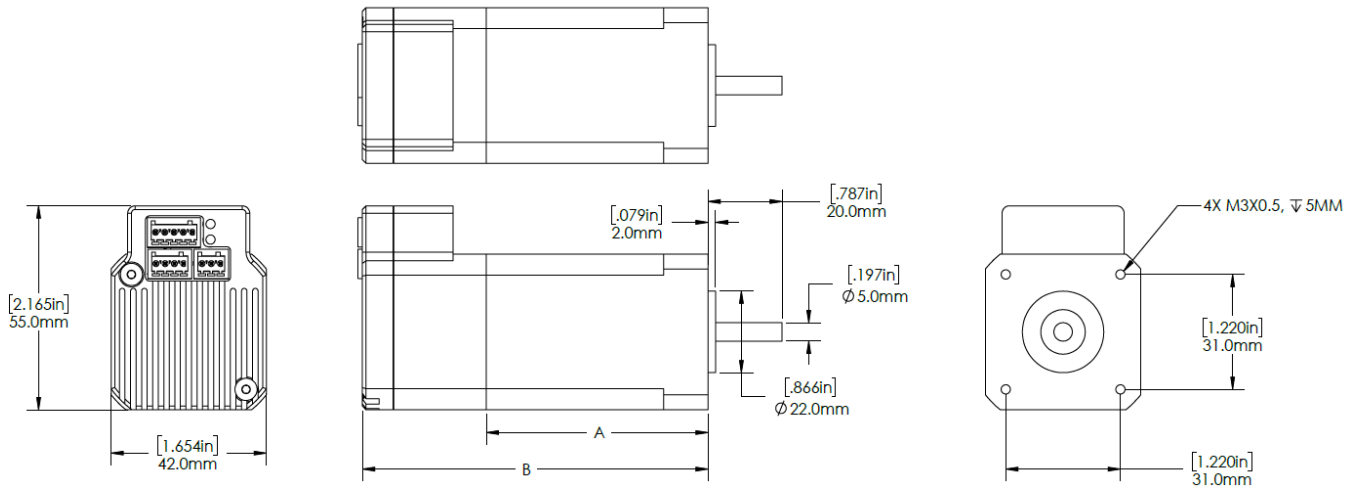

Table 1: Torque vs. Speed PNs

Line	PN
A	MMS742038-24-x1
B	MMS742052-24-x1
	MMS742077-24-x1
	MMS742105-24-x1

MECHANICAL DRAWING



Part Number	A (mm)	B (mm)
MMS742038-24-x1-1	40	73.5
MMS742038-24-x1-1	60	93.5
MMS742038-24-x1-1	80	113.5
MMS742038-24-x1-1	100	133.5

REVISION HISTORY

Revision #	Revision Date	Description	Pages Updated
1.0	10/5/2022	Initial Release	-

Notice: The information in this document is subject to change without notice. Please contact EZmotion for current specifications. Users should warrant and guarantee that third-party Intellectual Property rights are not infringed upon when integrating EZmotion products into any application. EZmotion will not assume any legal responsibility for any said applications.